

User Manual 2U Multi-Display Drawer



FC CE  REACH

4K 17" Display

3840 x 2160 native resolution / Display port 1.2 video input
1920 x 1080 & 1920 x 1200 resolution support

- MRP-K17-3** Triple display drawer
- MRP-K17-2L** Dual display drawer (LH mounted)
- MRP-K17-2R** Dual display drawer (RH mounted)

FHD 17" Display

1920 x 1080 native resolution / DVI-D + VGA video input

- MRP-F17-3** Triple display drawer
- MRP-F17-2L** Dual display drawer (LH mounted)
- MRP-F17-2R** Dual display drawer (RH mounted)

19" 4:3 Display

1280 x 1024 native resolution / DVI-D + VGA video input

- MRP-19-3** Triple display drawer
- MRP-19-2L** Dual display drawer (LH mounted)
- MRP-19-2R** Dual display drawer (RH mounted)

Legal Information

First English printing, January 2018

Information in this document has been carefully checked for accuracy; however, no guarantee is given to the correctness of the contents. The information in this document is subject to change without notice. We are not liable for any injury or loss that results from the use of this equipment.

Safety Instructions

Please read all of these instructions carefully before you use the device. Save this manual for future reference.

- Unplug equipment before cleaning. Don't use liquid or spray detergent; use a moist cloth.
- Keep equipment away from excessive humidity and heat. Preferably, keep it in an air-conditioned environment with temperatures not exceeding 40° Celsius (104° Fahrenheit).
- When installing, place the equipment on a sturdy, level surface to prevent it from accidentally falling and causing damage to other equipment or injury to persons nearby.
- When the equipment is in an open position, do not cover, block or in any way obstruct the gap between it and the power supply. Proper air convection is necessary to keep it from overheating.
- Arrange the equipment's power cord in such a way that others won't trip or fall over it.
- If you are using a power cord that didn't ship with the equipment, ensure that it is rated for the voltage and current labeled on the equipment's electrical ratings label. The voltage rating on the cord should be higher than the one listed on the equipment's ratings label.
- Observe all precautions and warnings attached to the equipment.
- If you don't intend on using the equipment for a long time, disconnect it from the power outlet to prevent being damaged by transient over-voltage.
- Keep all liquids away from the equipment to minimize the risk of accidental spillage. Liquid spilled on to the power supply or on other hardware may cause damage, fire or electrical shock.
- Only qualified service personnel should open the chassis. Opening it yourself could damage the equipment and invalidate its warranty.
- If any part of the equipment becomes damaged or stops functioning, have it checked by qualified service personnel.

What the warranty does not cover

- Any product, on which the serial number has been defaced, modified or removed.
- Damage, deterioration or malfunction resulting from:
 - Accident, misuse, neglect, fire, water, lightning, or other acts of nature, unauthorized product modification, or failure to follow instructions supplied with the product.
 - Repair or attempted repair by anyone not authorized by us.
 - Any damage of the product due to shipment.
 - Removal or installation of the product.
 - Causes external to the product, such as electric power fluctuation or failure.
 - Use of supplies or parts not meeting our specifications.
 - Normal wear and tear.
 - Any other causes which does not relate to a product defect.
- Removal, installation, and set-up service charges.

Regulatory Notices Federal Communications Commission (FCC)

This equipment has been tested and found to comply with the limits for a Class B digital device, pursuant to Part 15 of the FCC rules. These limits are designed to provide reasonable protection against harmful interference in a residential installation.

Any changes or modifications made to this equipment may void the user's authority to operate this equipment. This equipment generates, uses, and can radiate radio frequency energy and, if not installed and used in accordance with the instructions, may cause harmful interference to radio communications.

However, there is no guarantee that interference will not occur in a particular installation. If this equipment does cause harmful interference to radio or television reception, which can be determined by turning the equipment off and on, the user is encouraged to try to correct the interference by one or more of the following measures:

- Re-position or relocate the receiving antenna.
- Increase the separation between the equipment and receiver.
- Connect the equipment into an outlet on a circuit different from that to which the receiver is connected.

Contents

< Part. 1 >

1.1	Package Content	P.1
1.2	Structure Diagram & Dimension	P.1 - 3
1.3	Installation	P.5 - 8
1.4	Connection	P.10 - 11

< Part. 2 > Specifications / OSD

2.1	Product Specifications	P.12 - 15
2.2	On-screen Display Operation (OSD)	P.17 - 20

< Part. 3 > Options

3.1	3G / HD / SD- SDI Broadcast-grade input	P.21
3.2	HDMI video input	P.22
3.3	DC Power : 12V / 24V / 48V / 125V	P.23

Before Installation

- It is very important to mount the equipment in a suitable cabinet or on a stable surface.
- Make sure the place has a good ventilation, is out of direct sunlight, away from sources of excessive dust, dirt, heat, water, moisture and vibration.

Unpacking

The equipment comes with the standard parts shown in package content. Check and make sure they are included and in good condition. If anything is missing, or damaged, contact the supplier immediately.

How To Clean Your LCD Monitor



Caution :

- To avoid the risk of electric shock, make sure your hands are dry before unplugging your monitor from or plugging your monitor into an electrical outlet.
- When you clean your monitor, do not press down on the LCD screen. Pressing down on the screen can scratch or damage your display. Pressure damage is not covered under warranty.
- Use only cleansers made specifically for cleaning monitors and monitor screens. Cleansers not made to clean monitors and monitor screens can scratch the LCD display or strip off the finish.
- Do not spray any kind of liquid directly onto the screen or case of your monitor. Spraying liquids directly onto the screen or case can cause damage which is not covered under warranty.
- Do not use paper towels or abrasive pads to clean your monitor. Using an abrasive pad or any wood based paper product such as paper towels can scratch your LCD screen.

Cleaning Your Monitor

To clean your LCD safely, please follow these steps :

- ① Disconnect the power cord.
- ② Gently wipe the surface using a clean, dry microfiber cloth. Use as little pressure as possible.

Cleaning Tough Marks and Smudges

To remove tough marks and smudges, please follow these steps :

- ① Disconnect the power cord.
- ② Spray a small amount of non-abrasive cleanser on a microfiber cloth.



Caution : Do not spray or apply any liquids directly onto the monitor. Always apply the solution to your microfiber cloth first, not directly on the parts you are cleaning.

- ③ Gently wipe the surface. Use as little pressure as possible.
- ④ Wait until your monitor is completely dry before plugging it in and powering it up.

< Part 1 >

< 1.1 > Package Content



MRP-K17 unit X 1

- 6ft DP cable X 2 or 3
- Power adapter & Power cord X 1
- M6 screw, cage nut & cup washer X 8

MRP-F17 / MRP-19 unit X 1

- 6ft DVI cable X 2 or 3
- Power adapter & Power cord X 1
- M6 screw, cage nut & cup washer X 8

 The above package content is only for the pure model.
It varies with options such as SDI & DC power.

< 1.2 > Structure Diagram

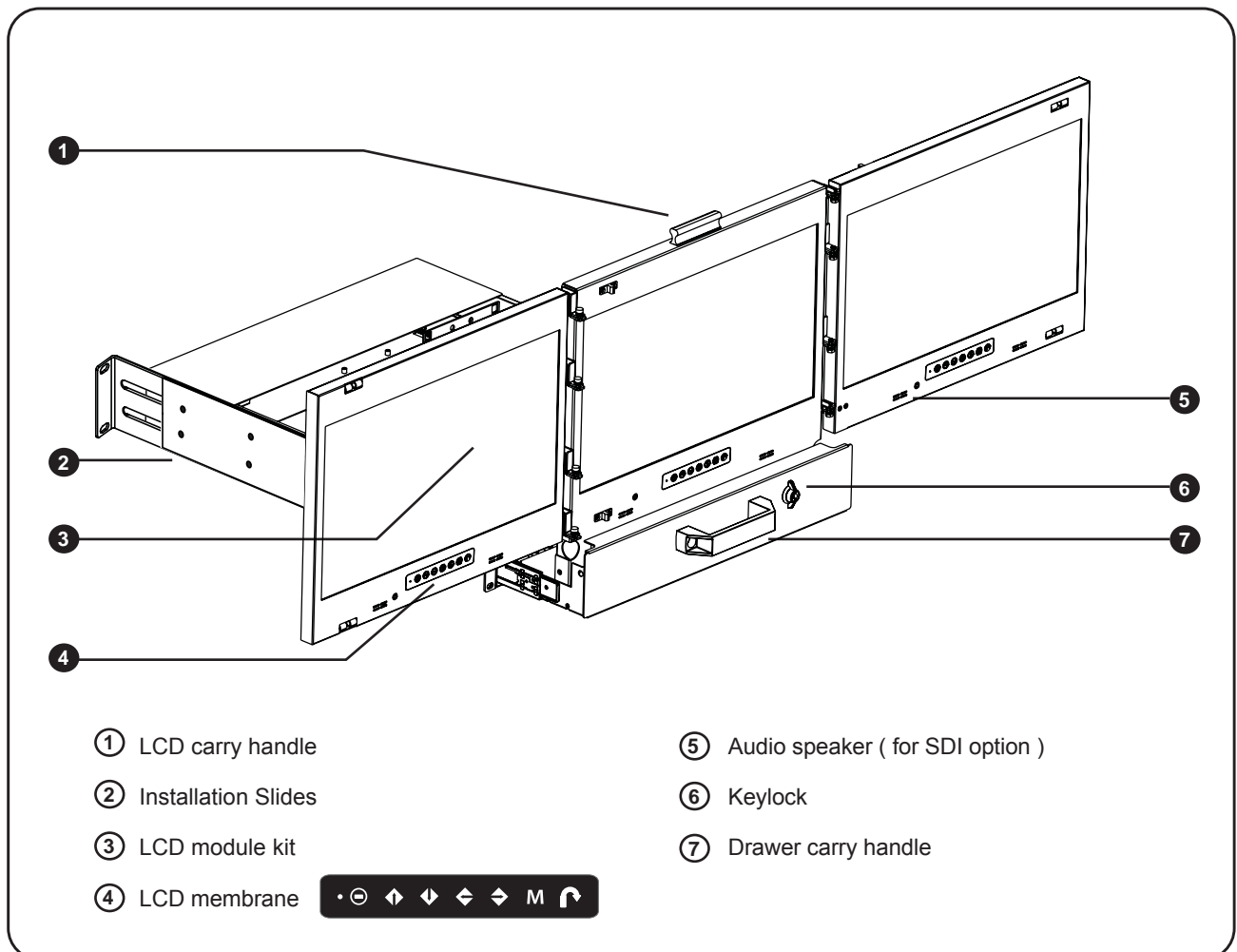

< 1.2 > MRP-K17 / MRP-F17 Dimension

1mm = 0.03937 inch

Front View

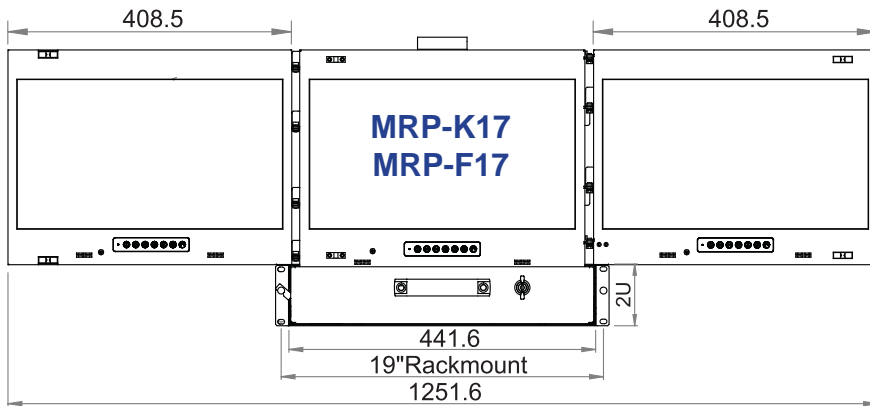

Triple display

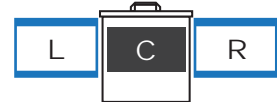

Dual display (LH mounted)

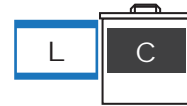

Dual display (RH mounted)



Rear View

MRP-K17

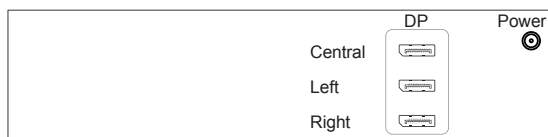

MRP-F17

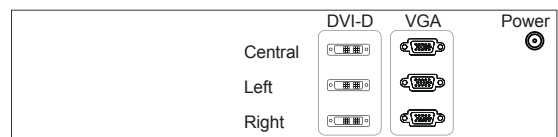

Side View

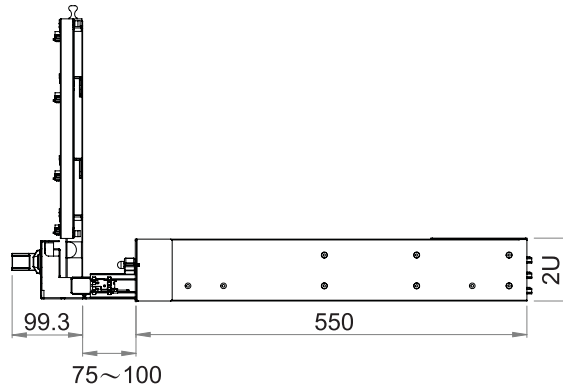

Top View

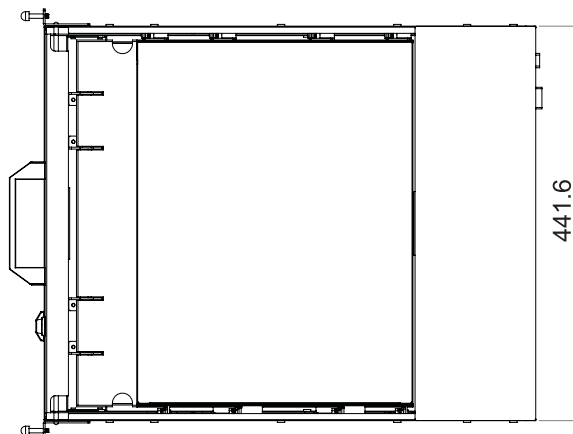

Model	Display	Product Dimension (W x D x H)	Packing Dimension (W x D x H)	Net Weight	Gross Weight	
MRP-K17 MRP-F17	-3	Triple	441.6 x 550 x 88 mm 17.4 x 21.7 x 3.5"	580 x 683 x 197 mm 22.8 x 26.9 x 7.8"	24.1 kg 53 lb	29.3 kg 64.5 lb
	-2L	Dual LH mounted	441.6 x 550 x 88 mm 17.4 x 21.7 x 3.5"	580 x 683 x 197 mm 22.8 x 26.9 x 7.8"	19.4 kg 42.7 lb	24.2 kg 53.2 lb
	-2R	Dual RH mounted	441.6 x 550 x 88 mm 17.4 x 21.7 x 3.5"	580 x 683 x 197 mm 22.8 x 26.9 x 7.8"	19.4 kg 42.7 lb	24.2 kg 53.2 lb

 The weight is only for the pure models. It varies with accessories & options .

< 1.2 > MRP-19 Dimension

1mm = 0.03937 inch

Front View

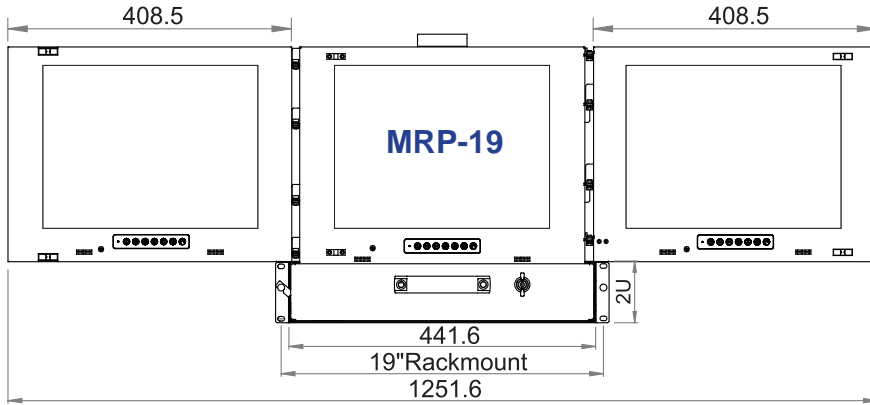

Triple display

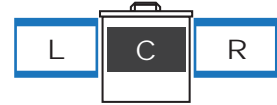

Dual display (LH mounted)



Dual display (RH mounted)



Rear View

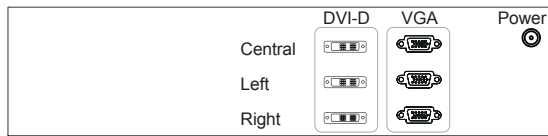

Side View

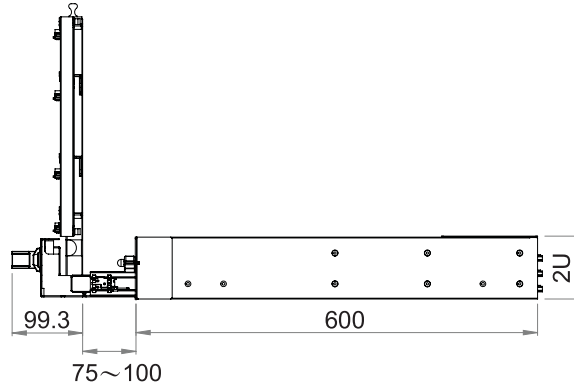

Top View

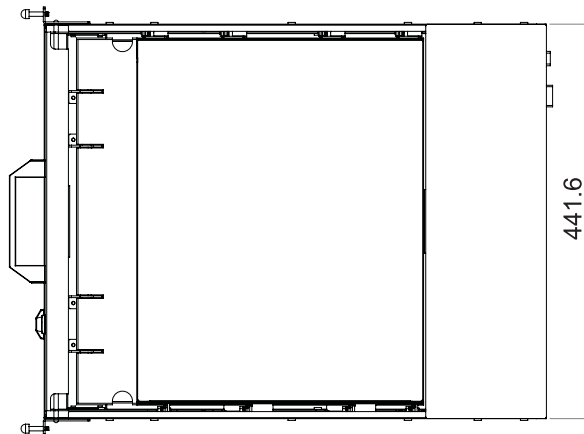

Model	Display	Product Dimension (W x D x H)	Packing Dimension (W x D x H)	Net Weight	Gross Weight
MRP-19	-3 Triple	441.6 x 600 x 88 mm 17.4 x 23.6 x 3.5"	580 x 683 x 197 mm 22.8 x 26.9 x 7.8"	25.1 kg 55.2 lb	30.3 kg 66.7 lb
	-2L Dual LH mounted	441.6 x 600 x 88 mm 17.4 x 23.6 x 3.5"	580 x 683 x 197 mm 22.8 x 26.9 x 7.8"	20.4 kg 44.9 lb	25.2 kg 55.4 lb
	-2R Dual RH mounted	441.6 x 600 x 88 mm 17.4 x 23.6 x 3.5"	580 x 683 x 197 mm 22.8 x 26.9 x 7.8"	20.4 kg 44.9 lb	25.2 kg 55.4 lb



The weight is only for the pure models. It varies with accessories & options .

Intentionally
Left
Blank

< 1.3 > Installation - How to install Installation Slides

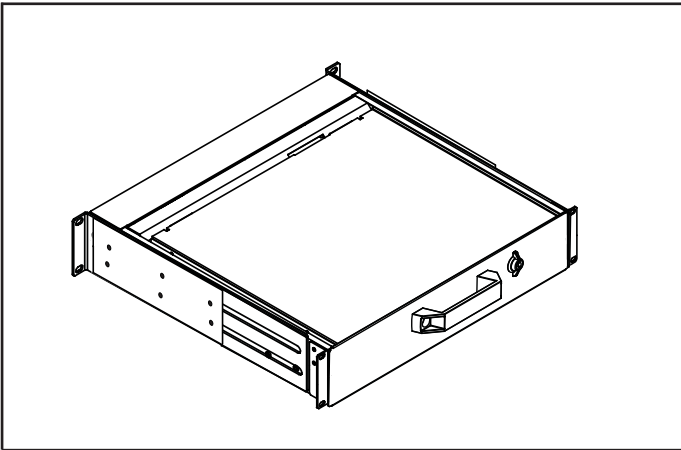

Step 1

- The left and right rear mounting brackets are attached to the Multi-display drawer.

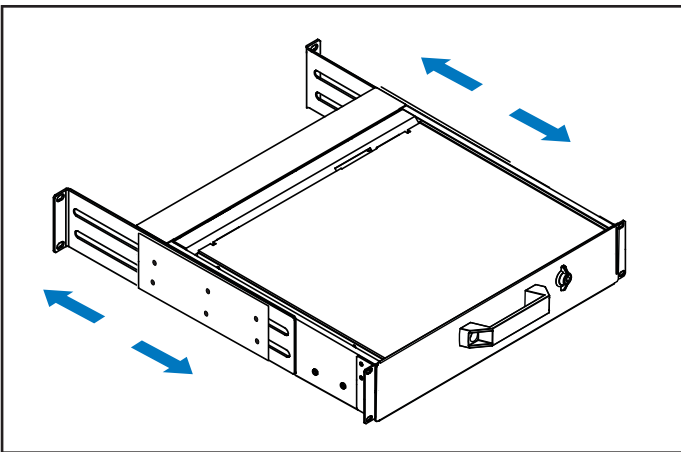

Step 2

- Measure the depth of the front and rear mounting rails.
- Align each rear mounting bracket to a suitable length.
- Mounting distance : 550 - 790 mm

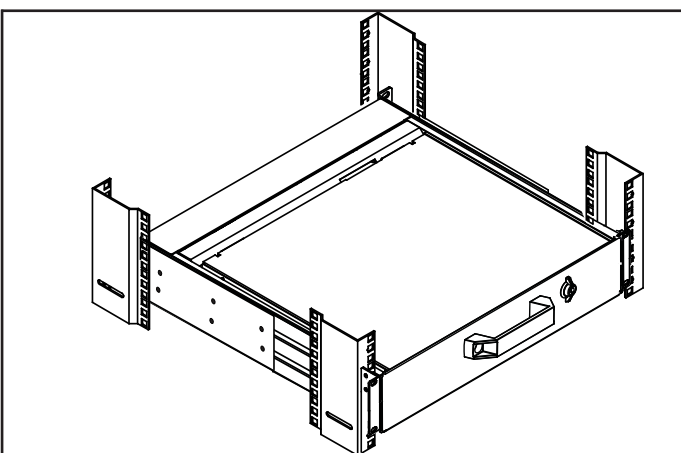

Step 3

Complete the installation

- Fix the Multi-display drawer into the rack.



M6 screw, cage nut & cup washer x 8 are provided.

< 1.3 > Installation - How to Use the **Multi-Display** Drawer

Step 1

- Unlock the key cylinder to 3 o'clock direction.



Step 2

- Hold the handle and slide out the drawer.



Step 3

- Flip up the LCD to a suitable angle.



Step 4

- Open the **Left** / **Right** display.



< 1.3 > Installation - How to Use the **Multi-Display** **Drawer**



Step 5

- Operate the multi-display drawer.



Step 6

- Close the **Left** / **Right** display.
- Flip down the LCD completely.



Step 7

- Must completely extend the drawer before returning it to the park position.
- Then pull and hold both side release buttons when pushing the drawer back to the rack.

! The above steps are necessary.
Failure to complete these will cause damage.



Step 8

- Return the multi-display drawer to park position.

< 1.3 > Installation - How to Use the Slides

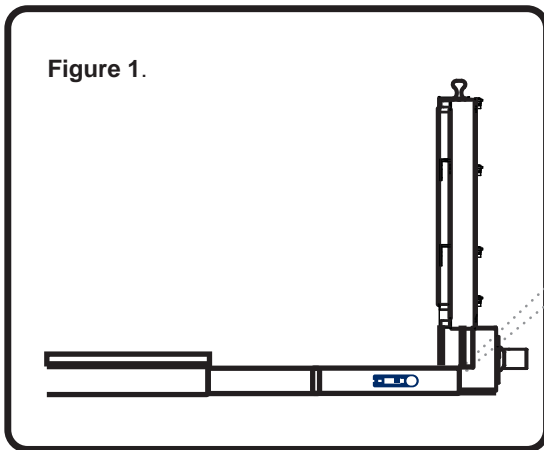

- A purple release button is located on the front of the slide. (shown in **Figure 1**).

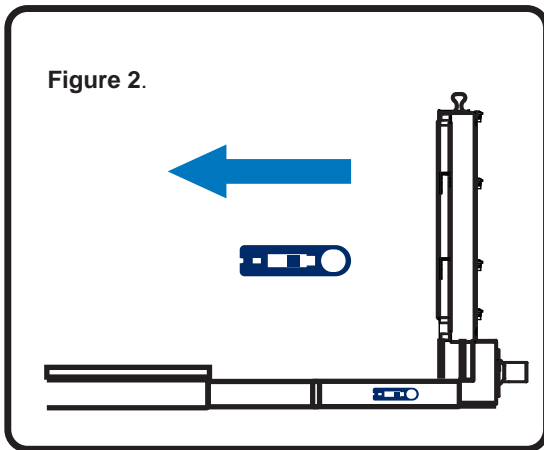

- Pull and hold both side release buttons when pushing the Multi display drawer back to the rack. (shown in **Figure 2**).

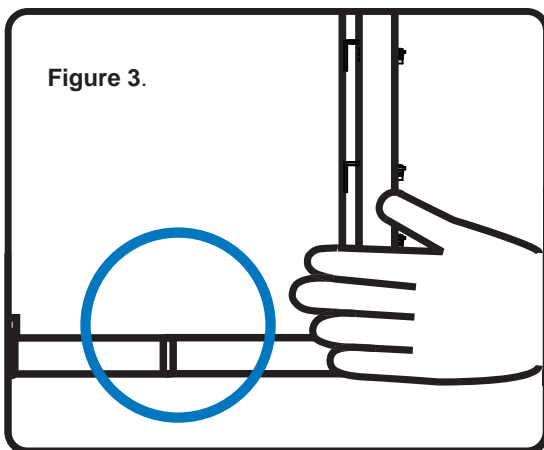

- ⚠ **Caution** : Keep your fingers away from the slide stop. (shown in **Figure 3**).

Intentionally
Left
Blank

< 1.4 > MRP-K17 connection to DP Server

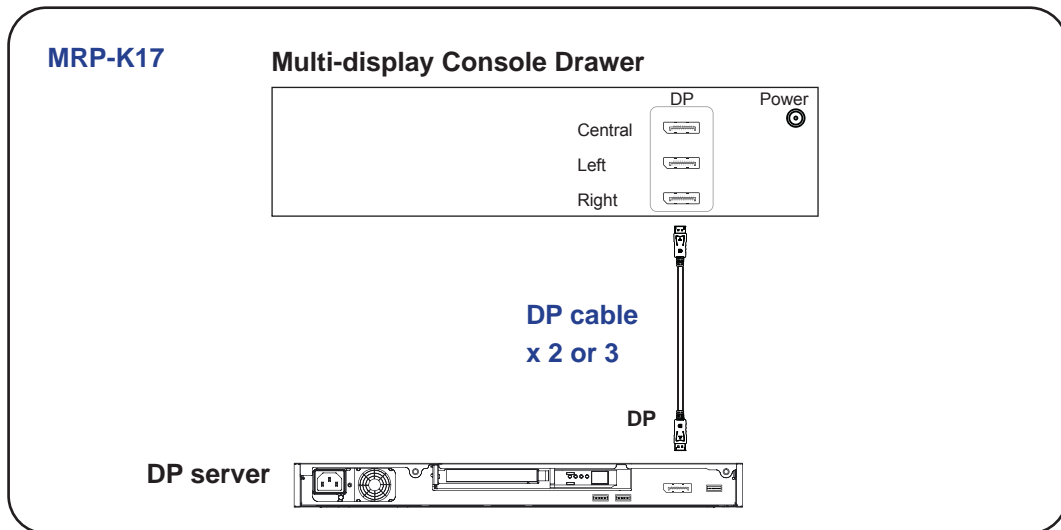

* DP cable x 2 for dual display



Caution : The LCD drawer is hot-pluggable, but components of connected devices, such as the servers and KVM switch, may not be hot-pluggable. Plugging and unplugging cables while servers and KVM are powered on may cause irreversible damage to the servers, KVM and LCD drawer. Before attempting to connect anything to the LCD drawer, we suggest turning off the power to all devices. Apply power to connected devices again only after the LCD drawer is receiving power. The company is not responsible for damage caused in this way.

< 1.4 > MRP-F17 / MRP-19 connection to **USB Server**

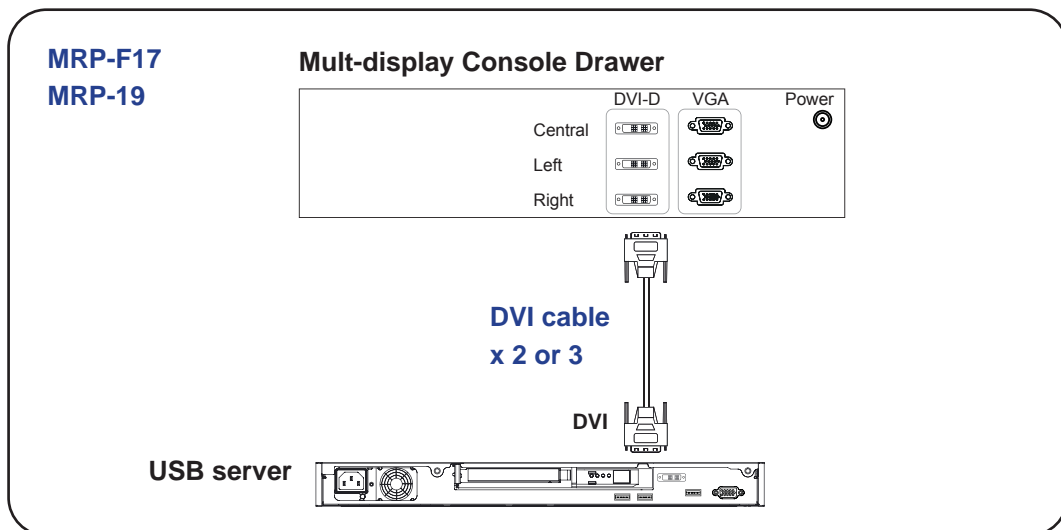

* DVI cable x 2 for dual display



Caution : The LCD drawer is hot-pluggable, but components of connected devices, such as the servers and KVM switch, may not be hot-pluggable. Plugging and unplugging cables while servers and KVM are powered on may cause irreversible damage to the servers, KVM and LCD drawer. Before attempting to connect anything to the LCD drawer, we suggest turning off the power to all devices. Apply power to connected devices again only after the LCD drawer is receiving power. The company is not responsible for damage caused in this way.

< Part 2 >

< 2.1 > Product Specifications - MRP-K17

LCD Panel		MRP-K17
	Native Resolution	3840 x 2160
	Panel Size (diagonal)	17.3-inch TFT color LCD
	Brightness (cd/m ²)	400
	Contrast Ratio (typ.)	1000:1
	Colors	16.7 M, 8-bit
	Viewing Angle (L/R/U/D)	89/89/89/89
	Response Time (ms)	Max. 30
	Dot pitch (mm)	0.0995
	Display Area (mm)	382.12H x 214.94V
	Surface treatment	Anti-glare
	Surface hardness	3H
	Backlight Type	LED
MTBF (hrs)	20,000	

Video	Package	DP 1.2 / HDCP 1.3
	Option	HDMI 2.0 / HDCP 2.2

Power	Power Supply	Range	Auto-sensing 100 to 240VAC, 50 / 60Hz
	Power Consumption	Screen ON	Max. 29W
		Power saving mode	Max. 9W
		Power button OFF	Max. 2W

Compliance	EMC	FCC & CE certified
	Safety	CE / LVD certified
	Environment	RoHS2 & REACH compliant

Environmental Conditions	Operating	Temperature	0 to 55°C degree
		Humidity	20~90%, non-condensing
		Altitude	16,000 ft
	Storage / Non-operating	Temperature	-20 to 60°C degree
		Humidity	5~90%, non-condensing
		Altitude	40,000 ft
		Shock	10G acceleration (11ms duration)
		Vibration	5~500Hz 1G RMS random

< 2.1 > Product Specifications - MRP-K17

Physical Specification	Product (W x D x H)		mm	441.6 x 550 x 88
			inch	17.4 x 21.7 x 3.5
	Packing (W x D x H)		mm	580 x 683 x 197
			inch	22.8 x 26.9 x 7.8
Weight	Net	Triple display		24.1 kg / 53 lb
		Dual display		19.4 kg / 42.7 lb
	Gross	Triple display		29.3 kg / 64.5 lb
		Dual display		24.2 kg / 53.2 lb

Applicable Format	Display Port Input	PC Signal	3840 x 2160 x 60Hz	
			1920 x 1080 x 60Hz	
			1600 x 1200 x 60Hz	
			1360 x 768 x 60Hz	
			1280 x 1024 x 60 / 75Hz	
			1280 x 768 x 60Hz	
			1024 x 768 x 60 / 70 / 75Hz	
			800 x 600 x 60 / 72 / 75Hz	
			720 x 400 x 70Hz	
			640 x 480 x 60 / 72 / 75Hz	
	Audio Signal	2ch Linear PCM		
	HDMI Input	HDMI 2.0	3840 x 2160 x 60Hz	
			HDMI 2.0 / 1.4	3840 x 2160 x 30Hz
				1920 x 1080 x 50 / 60Hz (1080p)
1920 x 1080 x 25 / 30Hz (1080i)				
1280 x 720 x 50 / 60Hz (720p)				
720 x 480 x 50 / 60Hz (576p / 480p)				
Audio Signal	2ch Linear PCM			

*In some circumstances, if the user connects the LCD to PC via HDMI port or video and audio signals, the LCD may display incorrectly on a full screen. If so, please adjust the display card setting on display size to fix the issue.

< Part 2 >

< 2.1 > Product Specifications - MRP-F17 / MRP-19

LCD Panel		MRP-F17	MRP-19
	Native Resolution	1920 x 1080	1280 x 1024
	Panel Size (diagonal)	17.3"	19"
	Brightness (cd/m ²)	400	250
	Contrast Ratio (typ.)	600:1	1000:1
	Colors	16.7 M, 8-bit	16.7 M
	Viewing Angle (L/R/U/D)	80/80/60/80	85/85/80/80
	Response Time (ms)	40	5
	Dot pitch (mm)	0.1989	0.294
	Display Area (mm)	381.888H x 214.812V	337.92H x 270.33V
	Surface treatment	Anti-glare, Hard-coating	Haze 25%, Hard-coating
	Surface hardness	3H	3H
	Backlight Type	LED	LED
	MTBF (hrs)	50,000	30,000

Video	Package	DVI-D + VGA	DVI-D + VGA
	Option	HDMI 1.3 / HDCP 1.3	HDMI 1.2 / HDCP 1.1

Power	Power Supply	Range	Auto-sensing 100 to 240VAC, 50 / 60Hz	
	Power Consumption	Screen ON	Max. 25W	Max. 25W
		Power saving mode	Max. 4W	Max. 4W
		Power button OFF	Max. 1W	Max. 1W

Compliance	EMC	FCC & CE certified
	Safety	CE / LVD certified
	Environment	RoHS2 & REACH compliant

Environmental Conditions	Operating	Temperature	0 to 55°C degree
		Humidity	20~90%, non-condensing
		Altitude	16,000 ft
	Storage / Non-operating	Temperature	-20 to 60°C degree
		Humidity	5~90%, non-condensing
		Altitude	40,000 ft
		Shock	10G acceleration (11ms duration)
		Vibration	5~500Hz 1G RMS random

< 2.1 > Product Specifications - MRP-F17 / MRP-19

Physical Specification	Product (W x D x H)	MRP-F17	mm	441.6 x 550 x 88
			inch	17.4 x 21.7 x 3.5
		MRP-19	mm	441.6 x 600 x 88
			inch	17.4 x 23.6 x 7.8
	Packing (W x D x H)		mm	580 x 683 x 197
			inch	22.8 x 26.9 x 7.8
	Net Weight	MRP-F17	Triple display	24.1 kg / 53 lb
			Dual display	19.4 kg / 42.7 lb
		MRP-19	Triple display	25.1 kg / 55.2 lb
			Dual display	20.4 kg / 44.9 lb
Gross Weight	MRP-F17	Triple display	29.3 kg / 64.5 lb	
		Dual display	24.2 kg / 53.2 lb	
	MRP-19	Triple display	30.3 kg / 66.7 lb	
		Dual display	25.2 kg / 55.4 lb	

Applicable Format	DVI-D / VGA Input	PC Signal	1920 x 1080 x 60Hz (MRP-F17 only)
			1360 x 768 x 60Hz (MRP-F17 only)
			1280 x 1024 x 60 / 75Hz
			1280 x 960 x 60Hz
			1280 x 768 x 60 / 75Hz
			1152 x 864 x 75Hz
			1024 x 768 x 60 / 70 / 75Hz
			848 x 480 x 60Hz
			800 x 600 x 60 / 72 / 75Hz
			720 x 400 x 70Hz
			640 x 480 x 60 / 72 / 75Hz
			640 x 400 x 70Hz
	640 x 350 x 70Hz		
		Audio Signal	2ch Linear PCM
	HDMI Input	PC Signal	Same as VGA
			HDMI 1.3
			1920 x 1080 x 25 / 30Hz (1080i) (MRP-F17 only)
			1280 x 720 x 50 / 60Hz (720p)
		720 x 480 x 50 / 60Hz (576p / 480p)	
	Audio Signal	2ch Linear PCM	





*In some circumstances, if the user connects the LCD to PC via HDMI port or video and audio signals, the LCD may display incorrectly on a full screen. If so, please adjust the display card setting on display size to fix the issue.

Intentionally
Left
Blank

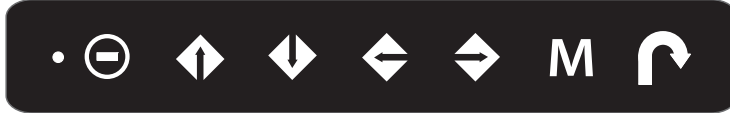
< 2.2 > On-screen Display Operation (OSD)

- Power light
- Green = On
- Orange = Power saving



Membrane Switch	Function
	Power on / off LCD
	Display the OSD menu
	Scrolls through menu options and adjusts the displayed control (To auto adjustment by pressing the button  for 5 seconds)
	Exit the OSD screen Toggle analog, digital & video connection (DVI-D and video options only)

< 2.2 > On-screen Display Operation (OSD) - MRP-K17

① Picture

Brightness : Adjust the screen brightness

Contrast : Adjust the difference between the image background (black level) and the foreground (white level)

Black level : Adjust background black level of the screen

Eco : Screen in power saving mode

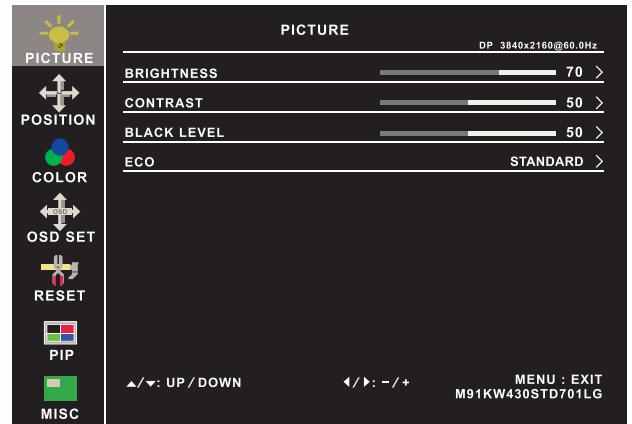

② Position

Picture size : Adjust the image size
- Full Screen / 4:3 / 5:4 / Pixel to Pixel

DP version : Select the DP version

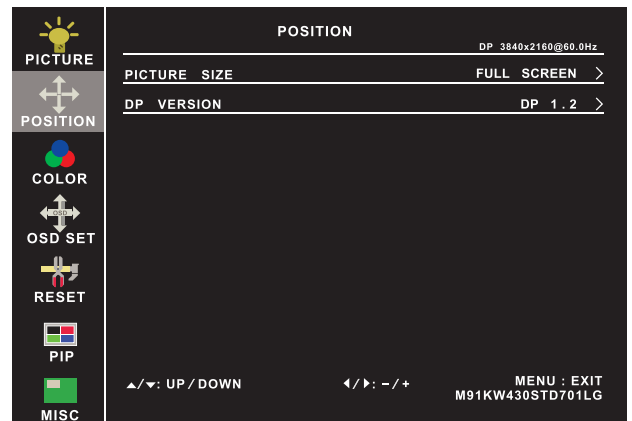

③ Color

Color temperature : User / Warm / Cool / 5400k mode and Red / Green / Blue color balance

Sharpness : Adjust the image from weak to sharp

Hue : Adjust the screen hue value

Saturation : Adjust the saturation of the image color

Dynamic luminous control : Control the dynamic brightness

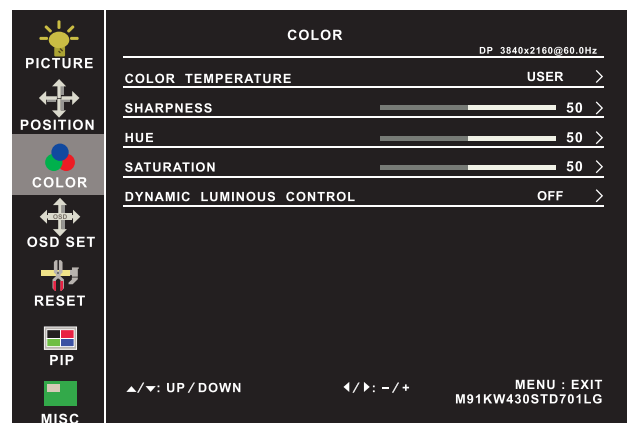

④ OSD Set

Language : Select the language in which the OSD menu is displayed - English

OSD H-Position : Align the screen image left or right

OSD V-Position : Align the screen image up or down

OSD time out : Adjust the screen timeout

OSD transparency : Adjust the screen transparency

OSD size : Adjust the screen size - Normal / Small

OSD rotation : Rotate the screen - 90° / 180° / 270°

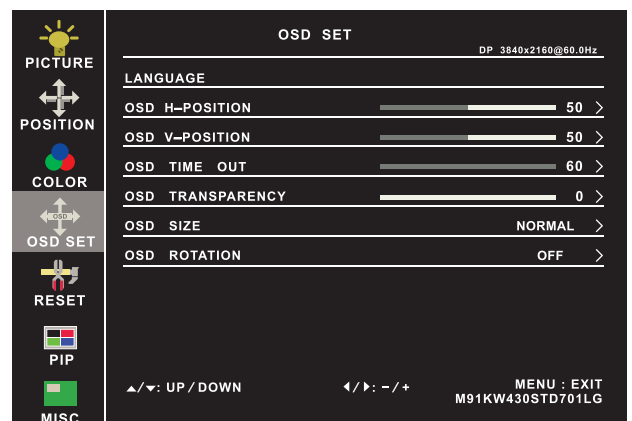

< 2.2 > On-screen Display Operation (OSD) - MRP-K17

⑤ Reset

Reset : Return the adjustment back to factory setting

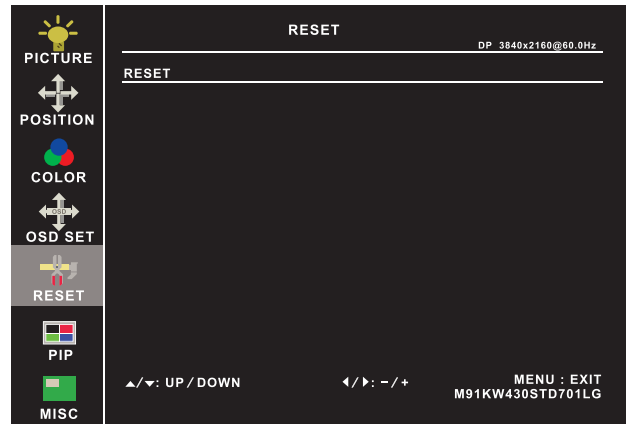

⑥ PIP

PIP mode : Enter into PIP / PBP setting - PIP MODE / PBP 2WIN (Main screen + 1 sub screen) / PBP 3WIN (Main screen + 2 sub screen) / PBP 4WIN (Main screen + 3 sub screen)
Select the signal input of each sub screen

PIP size : Adjust the size of the Sub screen
- Small / Medium / Large / Huge

PIP position : Adjust the position of the Sub screen
- Top Left / Top Right / Bottom Left / Bottom Right

Swap : Swap the input signal of PIP / PBP sub screen

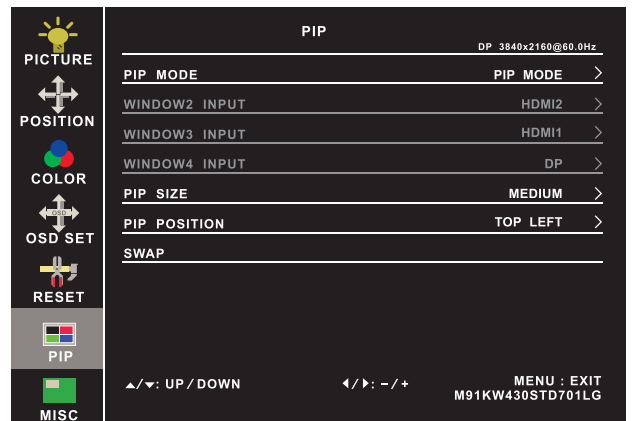

⑦ MISC

Signal source : Select the signal source - DP / HDMI1 / HDMI2

Mute : Turn off the surrounding sound

Audio in : Auto / Line in / DP

Volume : Adjust the volume of sound

Sleep mode : Set the off time - 10 min / 20 min / 30 min / 50 min / 60 min / 120 min / 240 min

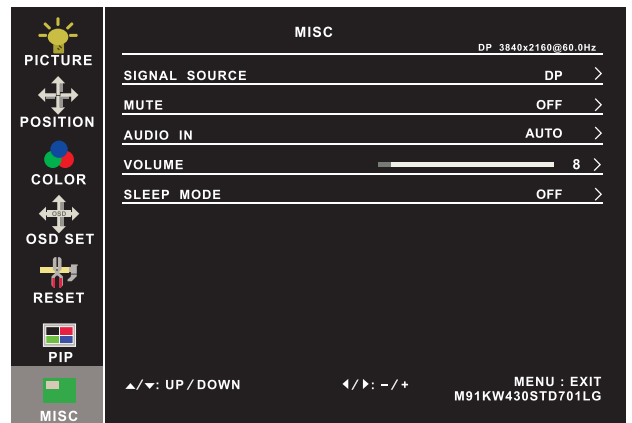

Options on Reset page



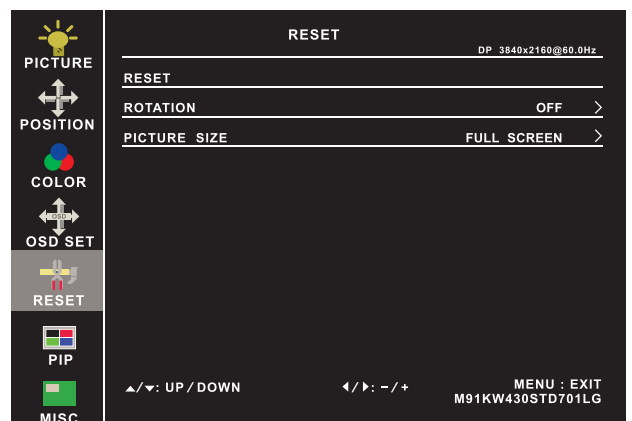

Rotation : Rotate the image in Full screen or 1:1
- 90° / 180° / 270°

Picture size : Adjust the image size in Full screen or 1:1



< 2.2 > On-screen Display Operation (OSD) - MRP-F17 / MRP-19

Ver: G56SN20SSTD701
1024 x 768 59.8Hz

Image

Brightness 50

Contrast 50

Color Temp User

Red 255

Green 255

Blue 255

OSD Configuration Page







Image:
for the brightness, contrast, color temp, red, green, and blue



Geometry:
for the auto adjust, H position, V position, phase and clock



Video:
for the colour, tint, sharpness, noise reduction, DCDi and TV Setup



Audio:
for volume, bass, treble, balance, AVL and mute



Misc:
for the language, OSD position, graphic mode, ratio, reset and timer

< Part 3 >

< 3.1 > Options : 3G / HD / SD-SDI input



SDI

Austin Hughes' SDI input is an ideal solution for the broadcast-grade video and high resolution CCTV market.

Designed for use with CyberView displays, a SDI input module can support up to 1080p @60Hz resolution without using additional space or power and it comes standard with a 2-year warranty.

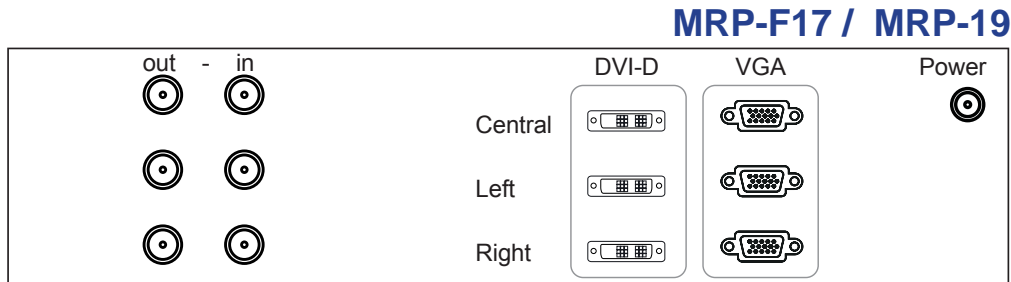
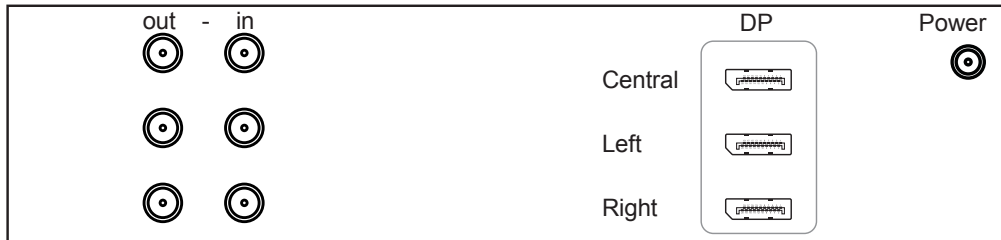

INPUT	3G-SDI IN	BNC x 1 / 0.8Vp-p (75 ohm)
	3G-SDI OUT	BNC x 1 / Active through, equalized & relocked
Standard Compliance	Video	SMPTE 425M / 274M / 296M / 125M ITU-R BT.656
	Audio	SMPTE 299M / 272M-C
Compatible Video Format	3G-SDI	1080p @60 / 50Hz, 4:2:2 1080p @30 / 25 / 24Hz, 4:4:4 1080i @60 / 50Hz, 4:4:4 720p @60 / 50Hz, 4:4:4
	HD-SDI	1080p @30 / 25 / 24Hz, 4:2:2 1080i @60 / 50Hz, 4:2:2 720p @60 / 50Hz, 4:2:2
	SD-SDI	480i @60Hz, 4:2:2
	ITU-R BT.656	576i @50Hz, 4:2:2
Compatible Audio Format	3G-SDI	48kHz, 16 / 20 / 24 bit, 2 CH, Synchronized Video
	HD-SDI	48kHz, 16 / 20 / 24 bit, 2 CH, Synchronized Video
	SD-SDI	48kHz, 16 / 20 / 24 bit, 2 CH, Synchronized / Asynchronized Video
Max. Transmission Distance 75 ohm coaxial cable	3G-SDI	150m at 2.97Gb/s
	HD-SDI	250m at 1.485Gb/s
	SD-SDI	480m at 270Mb/s

< 3.2 > Options : HDMI video input

MRP-K17 : HDMI 2.0 (HDCP 2.2)

MRP-F17 : HDMI 1.3 (HDCP 1.3)

MRP-19 : HDMI 1.2 (HDCP 1.1)



(1) In some circumstances, if the user connects the LCD to PC via HDMI port for video and audio signals, the LCD may display incorrectly on a full screen. If so, please adjust the display card setting on display size to fix the issue.

MRP-K17



MRP-F17 / MRP-19

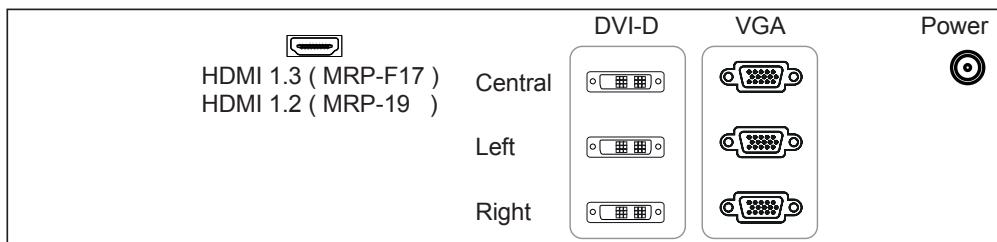

< 3.3 > Options : DC Power

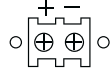

Model	12V	24V	48V	125V
Input rating				
Input voltage:	12-Volt	24-Volt	48-Volt	110-Volt
Input range:	9 ~ 18V	18 ~ 36V	36 ~ 75V	66 ~ 160V
Input current				
- No load	50 mA	50 mA	50 mA	35 mA
- Full load	4950 mA	2450 mA	1220 mA	460 mA
Output rating				
Output voltage:	12-Volt	12-Volt	12-Volt	12-Volt
Output current:	4.16A	4.16A	4.16A	4.16A
Efficiency	84%	88%	90%	89%

DC power

MRP-K17



MRP-F17 / MRP-19

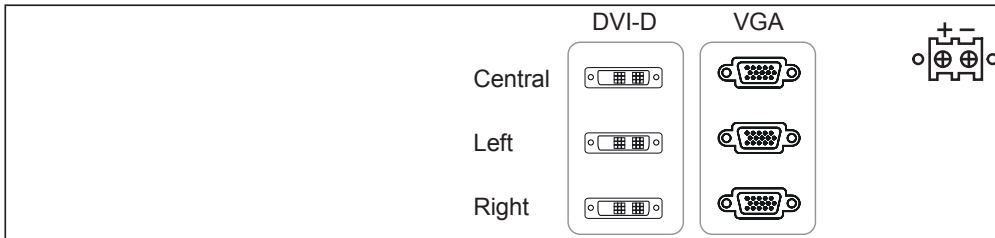

*** For DC power option :

(1) If the unit with LCD, earthing may be required 

(2) DC option excludes AC power adapter and power cord.

The company reserves the right to modify product specifications without prior notice and assumes no responsibility for any error which may appear in this publication.

All brand names, logo and registered trademarks are properties of their respective owners.